

Neptun SC1

IMPORTANT – READ FIRST

Only put the machine into operation once you have read and understood the operating manual. We shall be happy to answer any questions you may have.

HEUTE® sole cleaning machine Neptun SC1 cleans and disinfects dirty soles of working and safety shoes and boots. By means of an integrated hand brush bootlegs and plastic trousers can be cleaned effectively.

HEUTE® sole cleaning machines are built and tested in accordance with the latest safety regulations. The faultless functionality and operational assurance of the device can only be guaranteed if the generally applicable safety precautions and device-specific safety information in this operating manual are observed during use. The guarantee is not valid in relation to damages caused by a failure to observe this operating manual. The manufacturer assumes no liability for personal injury or damage to property arising as a result of this. In the event of problems please contact our service department immediately.

Intended use

HEUTE® sole cleaning machine Neptun SC1 is used to clean closed shoes and boots outside by means of an electrical driven brush and hand brush as well.

Other use is not permitted! Only use the spare parts approved for use with the machines by the manufacturer. Operation is only permissible in closed rooms whilst observing the specifications mentioned in the "Safety instructions" section.

Use in potentially explosive environment is not permitted.

Foreseeable misuse

The sole cleaning machine is not suitable for use as follows:

- Cleaning and care of human body parts and objects that are not parts of a shoe.
- Use as a tool for working on surface finishes
- Use with the addition of corrosive fluids

Safety instructions



Read this operating manual carefully and follow our advices for starting and for use.

The machine must not be changed or modified because this can lead to risks such as a short circuit, electric shock, fire. Maintenance and repairs must be carried out exclusively by authorised persons with the use of original parts.

The use of non-original spare parts or the implementation of unauthorised modifications to the machine will result in cancellation of the declaration of conformity issued by the manufacturer/distributor and CE sign as well.

Use the machine only in closed rooms.

Operation is only permissible at ambient temperatures between 0° C and 40° C.



The machine is not suitable for permanent operation. It is essential to consider the time of duration (KB) mentioned under section technical data - see page 14.

Do not continue to use the machine if the cleaning brushes are worn. This can result in damaging the shoes. The brushes must be replaced by a qualified person.



The design complies with protection class IP55. The voltage supply is 3-phase 400 V + grounding, power 0,18 kW. Observe the specific data provided on the manufacturer's type plate!



During use, the motor can heat up to temperatures of up to 90° C. Do not touch the motor without safety gloves.



Use by children, in particular when unattended, must be excluded.

Ensure that any contact between (household) animals and the machine is excluded.

For safety reasons please pay attention that during use of the rolling brush no laces and straps will touch the ground.

These can be caught by the rolling brush, which could cause injuries and damage of the shoes/boots.



Always disconnect the mains plug prior to cleaning, service and repair work. Do not continue to use the machine if the machine or the control cabinet with cabling, the water pipe and water drain are damaged.



Ensure that the installation is at ground level.

Enter and use the machine only with closed shoes/boots appropriate for wet cleaning.

Slip danger - pay attention to slippery ground in front of and besides the machine caused by splashing water.

Do not touch rotating brush.

Never drink the water out off the machine or the detergent liquid out of the container (option).

Excessive application pressure during use of the brush can lead to damage of shoes/boots!

Stop using the machine in case that brush stops and potential foreign objects cause malfunction.

The operator is responsible for all personal injury and damage to property that arises due to unintended use, faulty machine connections and/or operating errors.

When in commercial facilities observe the safety ordinance applicable on site as well as the accident prevention regulations issued by the union of professional associations for electrical systems and equipment.

Welcome

Dear Customer, we would like to thank you for purchasing one of our HEUTE industrial sole cleaning machines. You have purchased a quality product, which – if used correctly – will provide many years of satisfaction.

This operating manual is a constituent of the machine. It contains important information on commissioning, operation and maintenance. Please store this operating manual for future reference!

Scope of delivery

Sole cleaning machine with integrated hand brush, control cabinet, operating manual.

Declaration of conformity

The manufacturer herewith confirms that the following machine of type Neptun SC1 complies with the directives listed below:

- Machinery Directive (2006/42/EC)

Authorized representative Steffen Moersch,
contact details (see address of manufacturer)



Christian Löwe, Managing director
Maschinenfabrik HEUTE GmbH & Co. KG

Environmental protection

Disposal of transport packaging

The packaging materials in which your machine is supplied are environmentally friendly and recyclable. Please help by disposing of the packaging in an environmentally friendly manner. The packaging must not be given to children to play with. There is a risk of suffocation due to the folding box and plastic film.

Disposal of the product

Old devices that are no longer in use are not worthless waste. Valuable raw materials can be recovered through environmentally friendly disposal. Please inform yourself of the current disposal methods by contacting the person responsible within your company or your local authority

Table on contents

| | |
|---|-----------|
| Important – read first | 2 |
| Intended use | 2 |
| Foreseeable misuse | 2 |
| Safety instructions | 2 |
| Welcome | 3 |
| Scope of delivery | 3 |
| Declaration of conformity | 3 |
| Environmental protection | 3 |
| Overview | 4 |
| Installation and commissioning | 6 |
| General information | 6 |
| Transport and assembly | 6 |
| Water connection | 6 |
| Waste water connection | 6 |
| Electrical connection | 6 |
| Precaution while commissioning | 6 |
| Operation | 7 |
| How to clean | 7 |
| Adjustment of water quantity - access | 7 |
| Adjustment of water quantity | 7 |
| Use of sole cleaning function | 7 |
| Use of hand brush | 8 |
| Non-usage for longer time | 8 |
| Service and maintenance | 8 |
| Control | 8 |
| Cleaning | 8 |
| Maintenance | 8 |
| Recommended service intervals | 9 |
| Cleaning of surfaces | 9 |
| Cleaning and access to heavy waste-strainer | 9 |
| Cleaning of roller brush | 9 |
| Change of roller brush | 9 |
| Disassembling of brush axle | 10 |
| Access to gear motor | 10 |
| Dosing system - access | 11 |
| Dosing system | 11 |
| Dosing system - activation | 12 |
| Dosing system - rinsing | 12 |
| Trouble shooting | 13 |
| Technical data | 14 |
| Wiring diagrams | 15 |
| Part drawings | 17 |

Overview

Control cabinet
Dimension: 250 x 300 x 150 mm

Power supply 400 V,
3-phase + grounding
50Hz P=0,18kW

PVC hose to protect
electrical cables
(length 2 m)

Access to dosing
system of detergent /
disinfectant

Adjustable feet ABS

Hand brush with flexible PVC hose
and ball valve 1/2"

Brush \varnothing 150 mm, can be easily
removed without any tool for cleaning

Opening for cleaning of shoe/
boot tip and heels

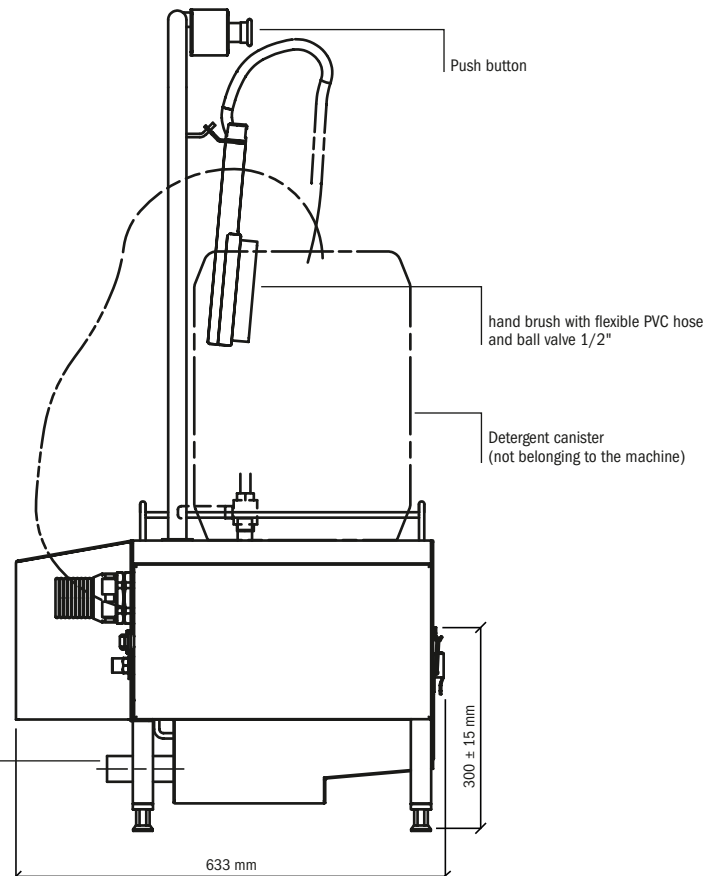

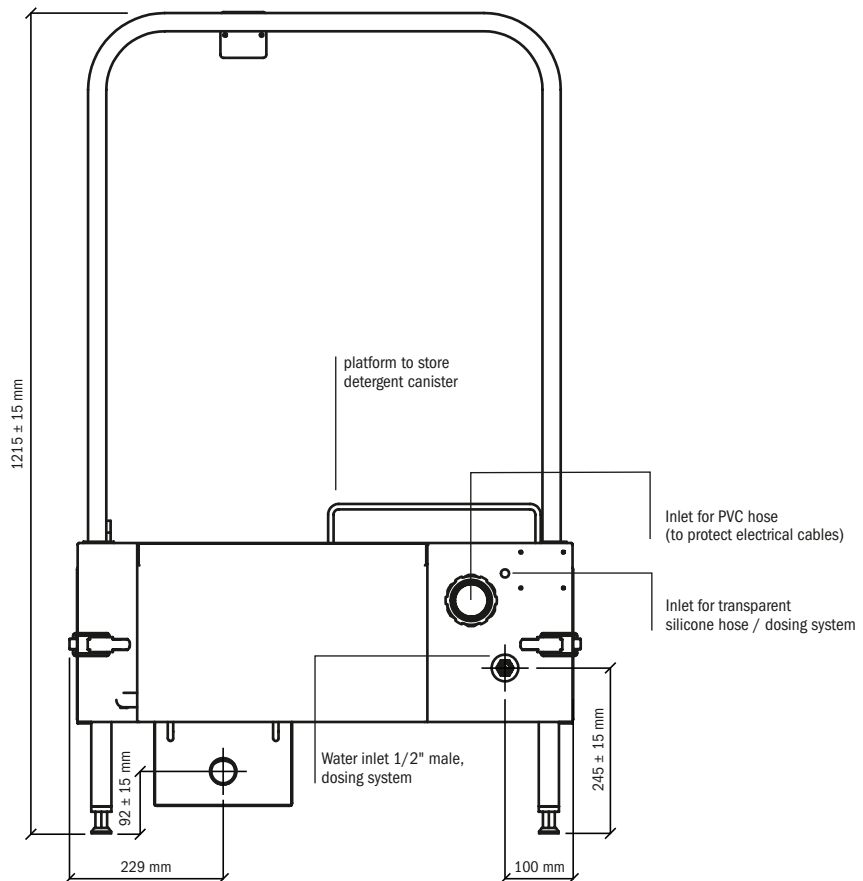
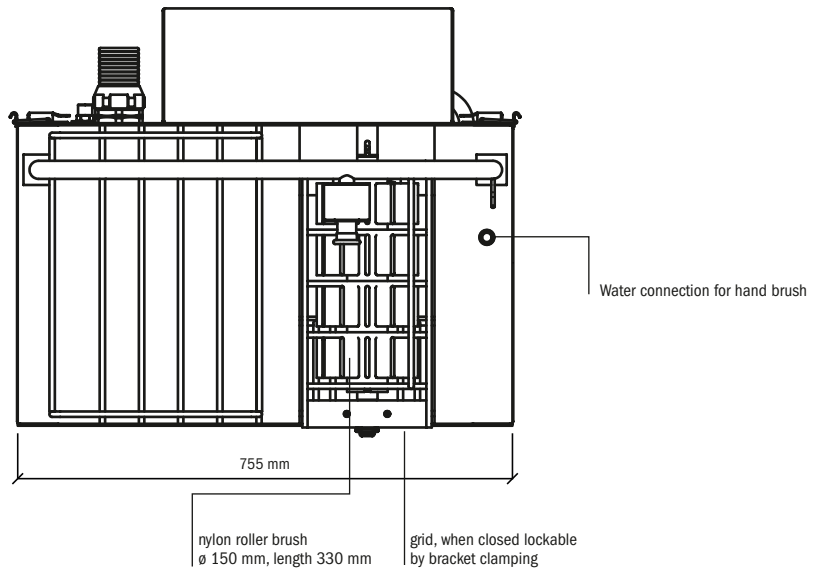

Installation and commissioning

General information

Please follow below mentioned advices to protect the stainless steel housing of the sole cleaning machine during storing, before installation, commissioning and use.

- Protect the machine against environmental influences like rain, sunshine and frost. Use the machine only in closed rooms.
- To avoid contact corrosion (e.g. steel spanes, tools used for steel treatment) the surface of the machine must not be in touch with other kind of steels

Transport and assembly

Weight of the machine is abt. 50 kg. Due to the heaviness transportation and unpacking should be done by 2 workers using suitable means of transport.

Only use the machine in closed rooms. When choosing the place of installation please consider the necessary space 755 x 640 mm, availability of waterinlet and -outlet, as well as power supply (more details see section **Installation and commissioning**). Control cabinet has to be fixed at suitable place on the wall. The ground must be level and slip protected. To ensure stability level out any uneven floor areas by adjusting the feet under help of a spirit level.

Water connection

- Inlet dia. 1/2"
- Advised operating pressure: 3 bar
- Maximum operating pressure: 6 bar
- Operating temperature between 30 °C and 50 °C (water temperatur more than 60 °C will damage the brush)
- Water flow rate: abt. 4 l/min with 3 bar (adjustable valve at the machine)

The machine is not equipped with an upstreamed return valve and water filtre. If necessary return valve and water filtre have to be installed before the unit. The requested water quantity can be individually adjusted – see sector **Operation** > *adjustment of water quantity*.

Put the detergent canister (not belonging to the machine) at suitable place (Fig. 1).



Fig. 1

Waste water connection

- Outlet ø 38 mm (Fig. 2)
- Provided with an access flap at the piping

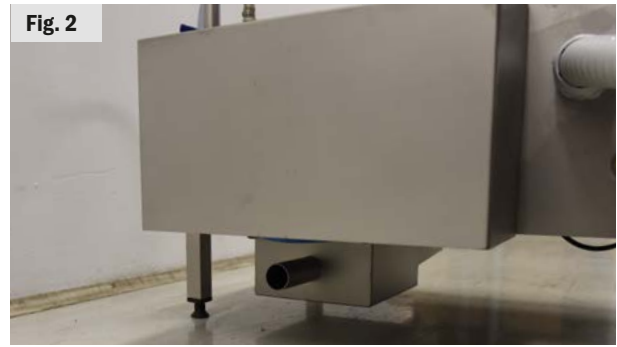

Fig. 2

Electrical connection

- 3-phase 400 V + grounding, power 0,18 kW
- Connection to the clamps in the control cabinet (see sector "**Technical data**" > *configuration of clamps*)
- ⚠ **Take care that available voltage in your country is corresponding to machine's voltage!**
- ⚠ **Machine's power supply must be electrically protected against indirect contacts!**
- High sensitive difference power protection device max. 30 mA.
- This protection must be provided by the house installation and is not supplied with the machine.
- The control cabinet should be mounted approx. 1,2 m above floor level.
- Turn-on and check rotating direction of the brush.

Precaution while commissioning

- ⚠ Never remove or block the contact switches on the housing, which are active when the grid is closed/down. When opening the grid during operation these will automatically turn off the water and power supply and will stop rotation of the brush.
- ⚠ The installation works for the water supply could cause soiling which can block the pipes, nozzles, dosing device and could damage the solenoid valve. It is important that the machine is free of metal and plastic parts, before it is connected to the electric circuit.

Operation

How to clean

- Cleaning of shoes/boots with horizontal roller brush (Fig. 3)
- Cleaning of shoe tip by means of separate cleaning opening underneath of horizontal roller brush – EasyClean function (Fig. 4)
- Supply of water and detergents, dosage by mixture in the dosing system

Fig. 3



Fig. 4



Adjustment of water quantity – access

The handwheel (valve) for adjusting the water quantity is located on the side. Remove the cover by opening the bracket clamping – no tools needed (Fig. 5)

Fig. 5



Adjustment of water quantity

The requested water quantity is adjustable by the valve (Fig. 6). The medium position allows a water flow of about 4 litres/minute.

Fig. 6



Use of sole cleaning function

Start the sole cleaning function by pressing the push button (Fig. 7) causing:

- Rotation of roller brush will start.
- Solenoid valve of the dosing system opens and starts spraying water and detergents on the rotating roller brush.
- Release push button to stop the sole cleaning process.

Fig. 7

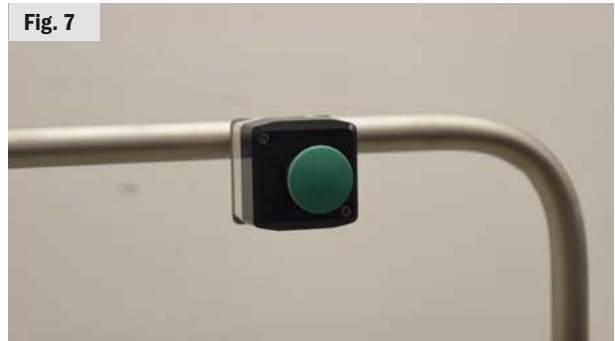

Use of hand brush

Bootlegs and plastic pans can be easily and effectively cleaned with the hand brush installed at right hand side (Fig. 8). Move the handle of the valve to adjust water quantity (Fig. 9). Medium opening allows a water flow of abt. 6 litres/minute.







Non usage for longer time

If you know that the machine will not be used for longer time (e.g. annual holidays), we advise to rinse the dosing system through in advance to avoid blockage of dosing system.

Service and maintenance

Service and maintenance should be carried out only by customer service technicians. To secure optimal functioning of the sole cleaning machine, it should be controlled in regularly intervals. HEUTE sole cleaning machines are service reduced and reliable. However, there are some components which will wear after long period of time and/or reduce the cleaning result.

-  Unplug the power supply at the control cabinet prior to all repairs.
-  Before any action stop water supply.
-  Drain the transparent silicone hose of the dosing system.
-  Rinse through the dosing system to remove residues.
-  In case of unintended opening of the grid the roller brush stops automatically and the solenoid valve will close the water supply.

Control

The machine should be controlled regularly. Take care if components are damaged or worn and if the machine achieves the necessary cleaning result. Foreign objects may not be nearby the roller brush.

Cleaning

The intervals of cleaning depends on local circumstances. The more dirt occurs the shorter should be the cleaning intervals. Don't forget to clean the dosing system regularly.

The mixture of used disinfectant and detergent should correspond with local regulations of hygiene and cleanness.

Maintenance

Neptun SC1 sole cleaning machine is service reduced and reliable. However, there are some components which will wear after long period of time and/or reduce the cleaning result, e.g. roller brushes.

Overused roller brushes are visible by bent down and too softy bristles.

Suitable spare parts are available from your local dealer or from manufacturer.

Advices to change spare parts please read more in section "**Service and maintenance**".

Recommended service intervals

Below mentioned intervals are based on our experience. However, any single case could vary from each other. That is the reason why you have to adapt the intervals according to your own experience.

| Service | Interval |
|----------------------------------|---|
| Control | once a week |
| Cleaning of surfaces | once a week |
| Cleaning of heavy waste strainer | once a week |
| Cleaning of brushes | once a month |
| Cleaning of dosing system | once a month, strictly when changing the medium |
| Change of roller brush | every 5-7 years, earlier when worn |

Change of roller brush

1. Lift up the grid to have access to the roller brush. It can be removed without any special tool (Fig. 10).
2. Roller brush: Pull it at the front side. The gear of roller brush happens by a pin located at the motor side (Fig. 11).
3. When insert the roller brush pay attention that the pin is in the right position and the brush fits properly.



Cleaning surfaces

The surface is made of stainless steel type 304.

Cleaning should be done by intensive water rinsing. Avoid following:

- contact with carbon steel
- use of steel sponge, grinding powder
- use of chlorine products and bleaching agent

Cleaning and access to heavy waste strainer

Remove roller brush first - see section "**Service and maintenance**" > *Change of roller brush*.

Lift up the heavy waste strainer to remove (Fig. 12). Insertion in reversed order.



Cleaning of roller brush

Cleaning of roller brush should be done by intensive water rinsing or by soaking in suitable detergent. Never use chlorine products and bleaching agent. Use of high pressure cleaner is strictly forbidden. Overused roller brushes are visible by bent down and too softy bristles.

Disassembling of brush axle

1. Remove roller brush (see section "**Service and maintenance**" > *Change of roller brush*)
2. Remove inbus screw placed at the long side in front of the brush with suitable tool (Fig. 13)
3. Remove snap ring located at front side of the brush with suitable tool and pull off the distance washer (Fig. 14)
4. Now the brush can be pulled off the axle (Fig. 15)
5. When assembling put the pin in the center position of the brush, fix the inbus screw, insert distance washer (\varnothing 30 mm) and snap ring.

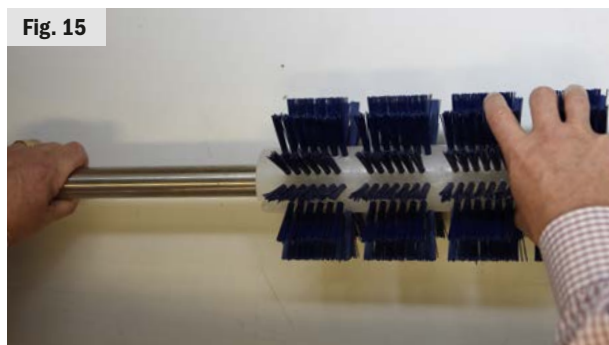
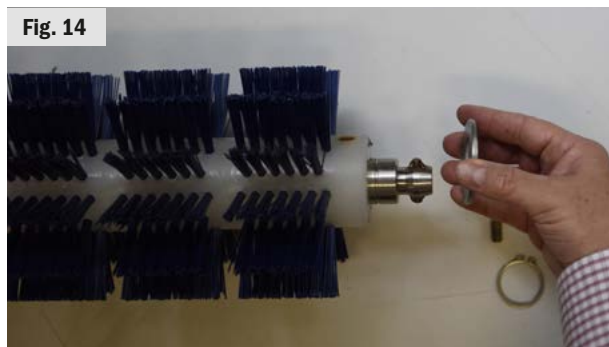
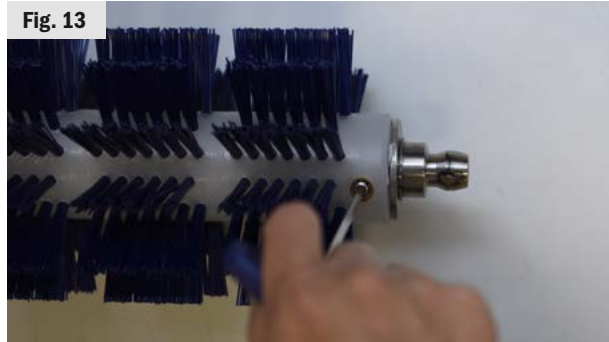

Access to the gear motor

The cover at the rear is not fixed.
Just remove the cover vertical up. No tools are required (Fig. 16).

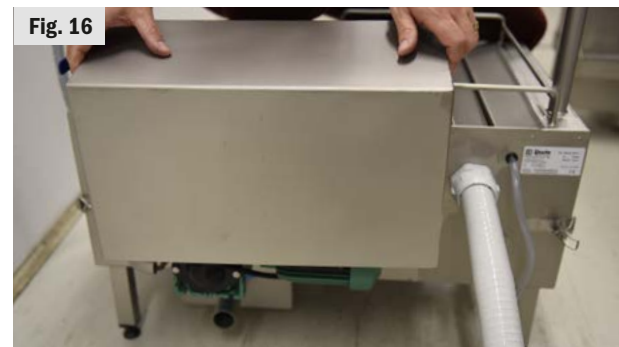

Dosing system - access

Remove the cover by opening the bracket clamping - no tools required (Fig. 17).

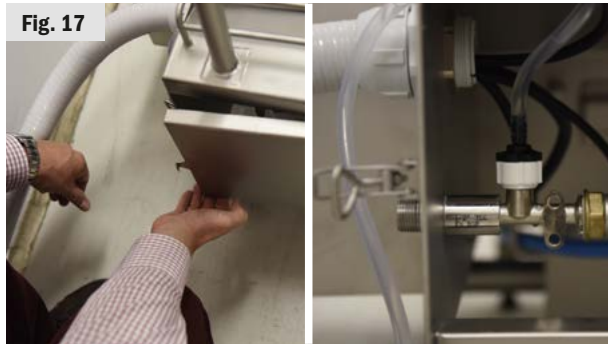

Dosing system

The dosing system prepares the mixture of water and detergent/disinfectant in a certain proportion. This proportion will be determined by the installed nozzle.

To achieve optimal function use products having the same viscosity than water. Don't use crystallised detergent/disinfectant.

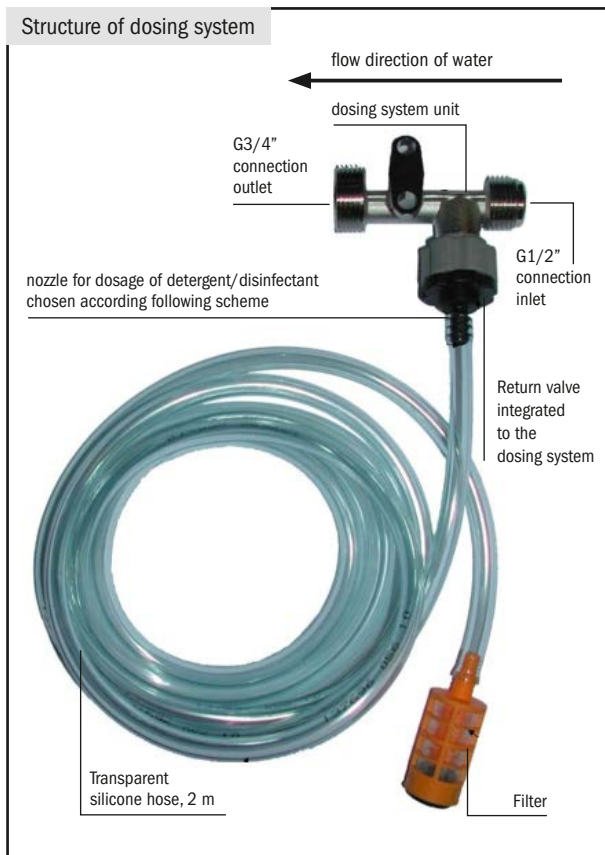

The dosage of detergent/disinfectant is done by nozzles in different sizes - supplied with the machine (Fig. 18). To achieve the desired concentration choose the corresponding nozzle (see below scheme). The indications should be treated as guideline to find the requested concentration. Achieving optimal dosing results, tests should be made.

The transparent nozzle is a stopper.

Fig. 18



| Colour of nozzle | Admixture of detergent/disinfectant |
|------------------|-------------------------------------|
| without | 22,00 % |
| grey | 21,20 % |
| black | 21,00 % |
| beige | 17,00 % |
| red | 12,20 % |
| white | 9,00 % |
| blue | 7,60 % |
| light brown | 5,20 % |
| green | 4,10 % |
| orange | 3,10 % |
| dark brown | 2,50 % |
| yellow | 1,90 % |
| turquoise | 1,10 % |
| purple | 0,94 % |
| pink | 0,35 % |
| transparent | 0,00 % (used as stopper) |

1. Have a look at the structure of dosing system - see section **"Service and maintenance"** > Dosage > Structure of dosing system.
2. Loose the transparent silicone hose by turning from the return valve.
3. Plug the chosen nozzle with the narrow side on to the return valve.
4. Plug transparent silicone hose on to the return valve. Take care that the hose is wholly plugged and is not bended.

Dosing system – activation

Activation of detergent/disinfectant happens by water rinse of the system

- 1.** During initial operation put the filter device located at the end of the transparent silicone hose into the detergent canister (Fig. 19) – not belonging to the machine.
Detergent/disinfectant should not contain chlorine bleaching ingredients because it could damage the surface, brushes and other components.
- 2.** Turn on the machine by pressing the push button until the dosing medium has reached the level of the mixing tap (Fig. 20). To achieve optimal function and mixture use products having the same viscosity than water (water = viscosity of 1). Media having higher viscosity (semifluid) could cause problems.

Fig. 19



Fig. 20



Dosing system – rinsing

We recommend to rinse the system for the detergent / disinfectant regularly. However, basically when changing the detergent / disinfectant canister or during maintenance work cleaning should be done. Put the transparent silicone hose with filter device into a canister with clear water and start the machine for 20-30 seconds.

Sediments and foreign objects could cause damage to the machine. If the machine has not been used for a longer time we advise to check that transparent silicone hose and filter device are free of sediments. Just in case rinse the dosing system with clear water.

Trouble-shooting only by qualified personnel

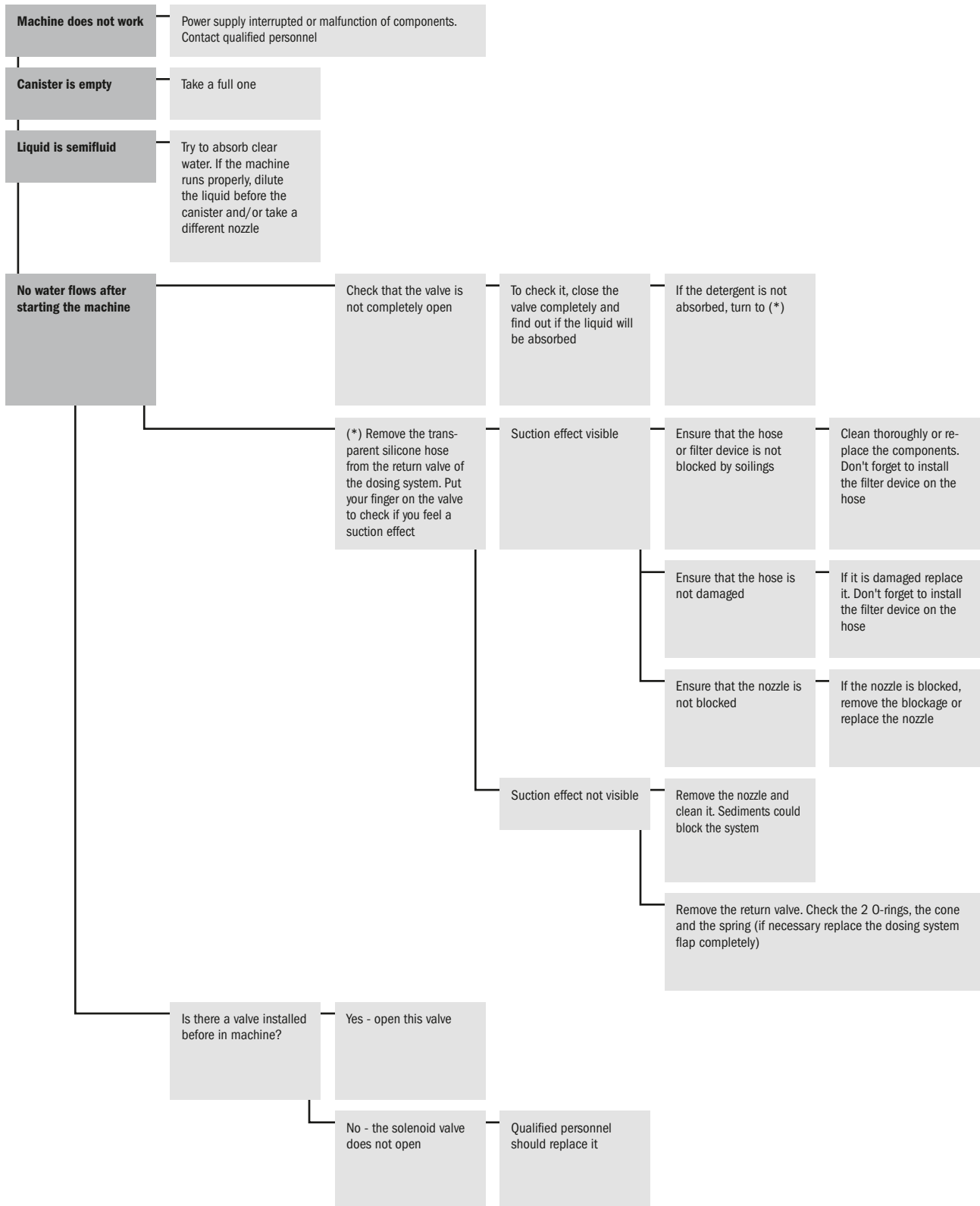

Trouble-shooting only by qualified personnel

? Machine operates without water

! Water supply is closed or interrupted

✓ Check water supply

? Machine does not drain off waste water

! Water outlet is blocked

✓ Check water outlet - if necessary remove blockage

? Motor stops or runs improperly

! Foreign objects inside

✓ Unplug immediately the machine from power supply. Search and remove foreign objects (turn roller brush by hand)

? Machine makes much noise during operation

! Foreign objects inside

✓ Unplug immediately the machine from power supply. Search and remove foreign objects (turn roller brush by hand)

or

! Check correct installation of roller brush

Technical data:

Dimensions: 76 cm x 63,5 cm x 121,5 cm
(width x depth x height)

Weight: 50 kg

Connection load: 3-phase 400 V + grounding

Power: 0,18 kW

Protection category: IP55

Short term operation time (KB): 8 min

Noise emission: less than 80 dB(A)

Wiring diagrams Neptun SC1

Wiring diagram I

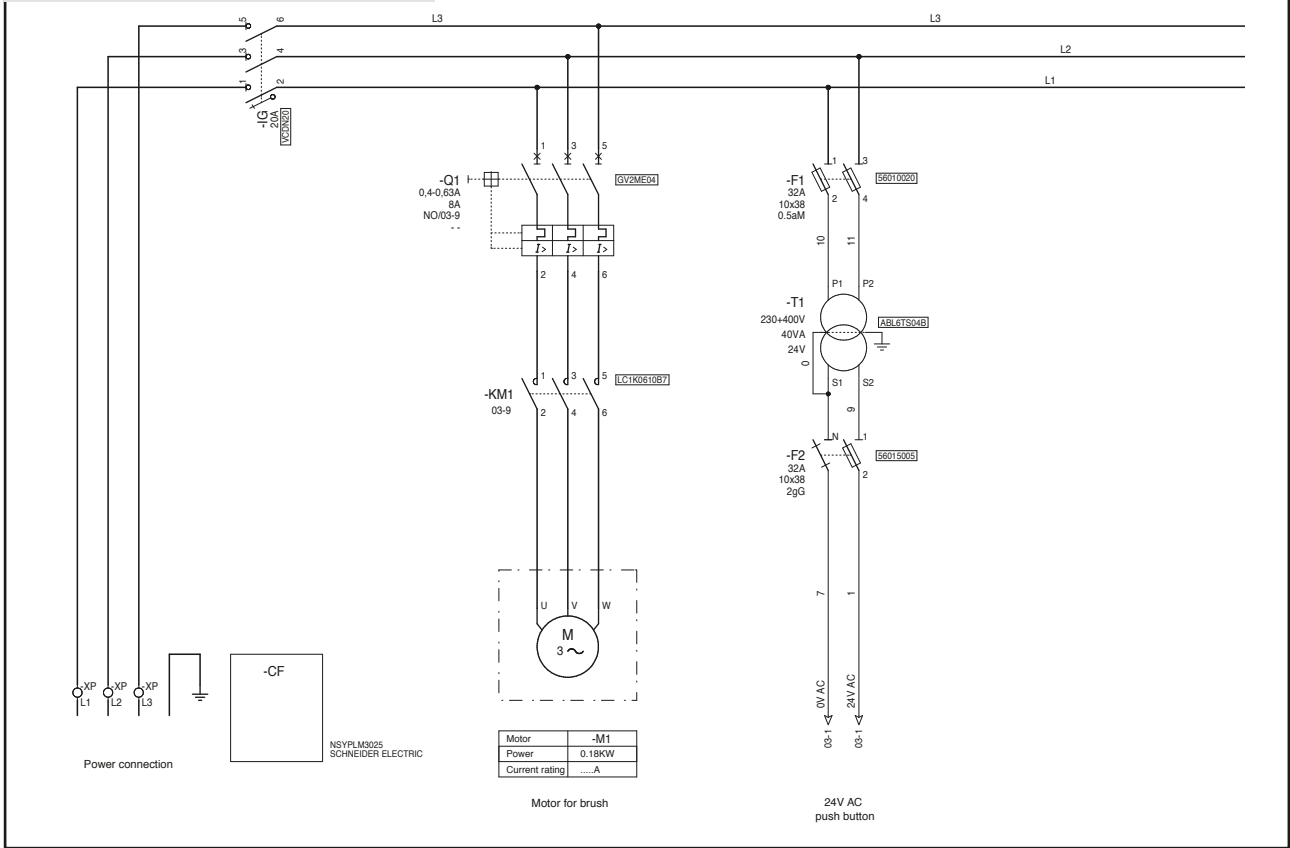

Wiring diagram II

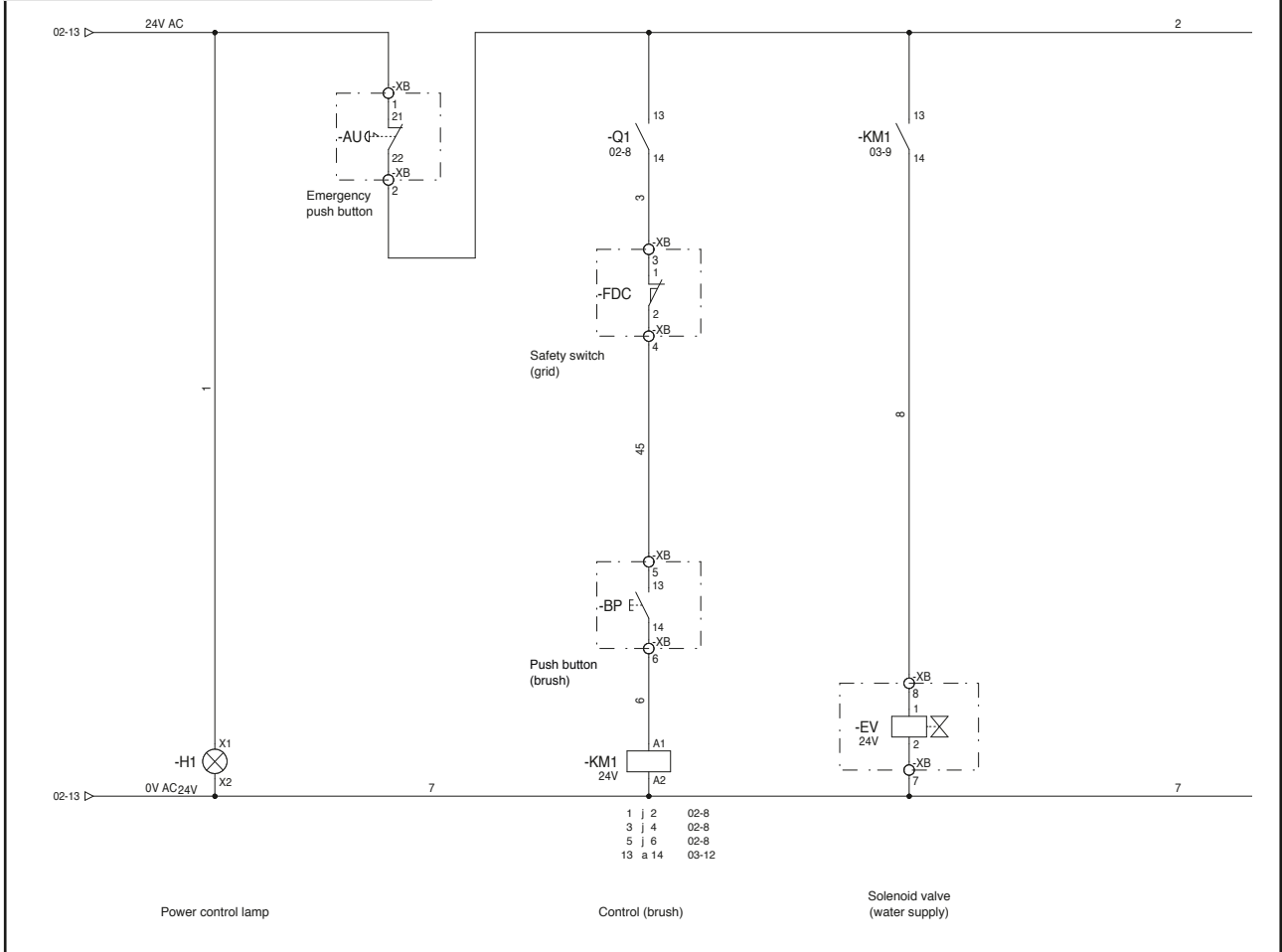

Configuration clamping strip I

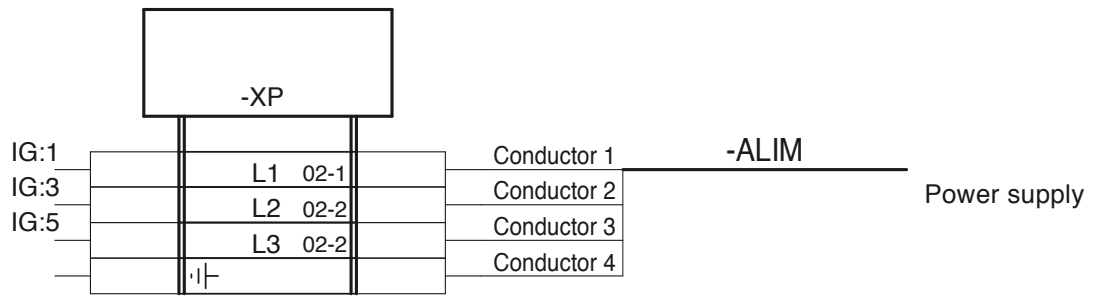

Configuration clamping strip II

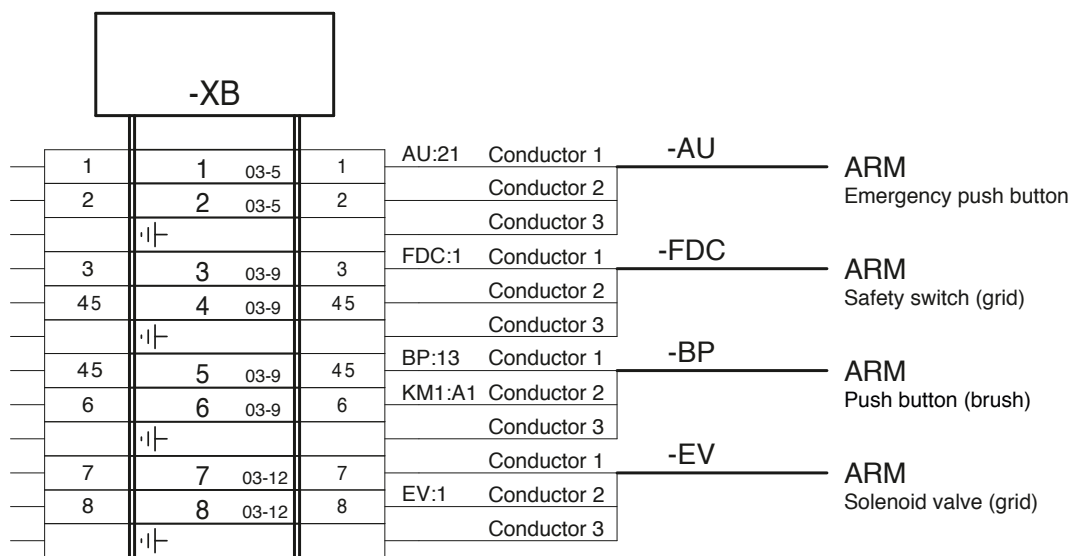

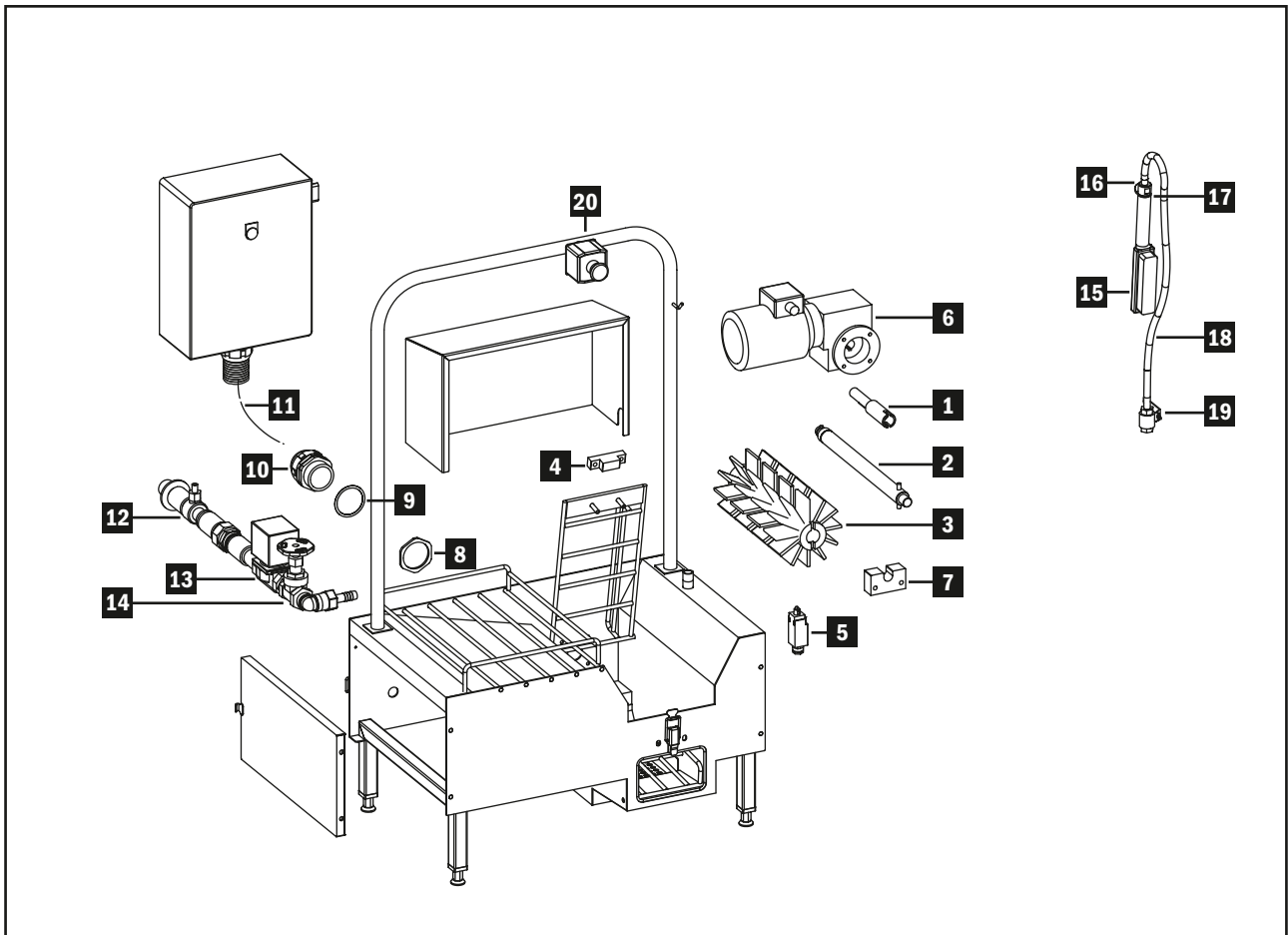

| Item | Article | Article No. |
|------|---|-------------|
| 1 | Coupling stainless steel + spring, 6 x 6 x 30 mm | 06800101 |
| 2 | Axle for brush, \varnothing 150 x 330 mm, stainless steel 304 | 06800102 |
| 3 | Brush blue, \varnothing 150 mm, length 330 mm PBT | 06800103 |
| 4 | Stop Nylatron GSE | 06800104 |
| 5 | Position switch XCKP102 | 06800105 |
| 6 | Gear motor MB2101 M50C LS63 $p=0,18kW$ | 06800106 |
| 7 | Bearing Nylatron GSE | 06800107 |
| 8 | Nut Perfect CEPFV36 | 06800108 |
| 9 | Gasket for connection piece PG36 | 06800109 |
| 10 | Connection piece, grey, PG36 | 06800110 |
| 11 | PVC hose GP, 40 x 46 - 2 lg = length 2 m | 06800111 |
| 12 | Dosing device chromed brass, \varnothing 2,6 mm | 06800112 |
| 13 | Solenoid valve 24V-50Hz-NF-1/2", \varnothing 11,5 mm | 06800113 |
| 14 | Valve to adjust water quantity, brass, 1/2" | 06800114 |
| 15 | Hand brush | 06800115 |
| 16 | Coupling for hand brush, stainless steel 304 | 06800116 |
| 17 | Fixing piece for hand brush, stainless steel 304 | 06800117 |
| 18 | Flexible PVC hose, length 1500 mm | 06800118 |
| 19 | Ball valve, stainless steel 1/2" | 06800119 |
| 20 | Push button | 06800120 |

This operating manual contains descriptions of our products, but it does not give any warranties for specific properties or operational results. Authoritative is, unless otherwise specified, only the technical base, at the time of delivery of the goods in combination with this manual, by Maschinenfabrik HEUTE GmbH & Co. KG. The products and their design are subject to constant changes / improvements. We reserve the right to apply technical changes, anytime.

This manual is protected by copyrights. All rights reserved. This manual shall not be copied, translated, or otherwise modified, unless explicitly accepted, in writing, by the manufacturer (Maschinenfabrik HEUTE GmbH & Co. KG).



Weinsbergtalstraße 2 · 42657 Solingen · Germany
Phone: +49(0)212-380 310 · Fax: +49(0)212-380 31-49
E-mail: info@heute-gmbh.de · Internet: www.heute-gmbh.de